

Guide pillar with centering collar BR00

Guía con centrador BR00

Słup prowadzący

Guia principal com centrador BR00

Colonne de guidage epaulée avec plot de centrage BR00

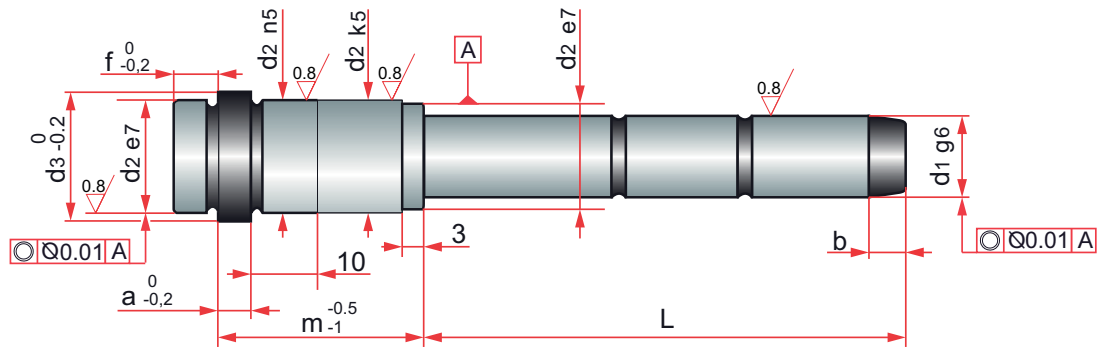

Hardness: 58 ± 2 HRC.

a	b	f	d3	d2	d1	m	L	REF.	d1	REF.
3	4	3	16	14	10	12	25	BR00/10x012x025	-	-
							35	BR00/10x012x035		
							55	BR00/10x012x055		
						17	25	BR00/10x017x025		
							35	BR00/10x017x035		
							55	BR00/10x017x055		
						22	25	BR00/10x022x025		
							35	BR00/10x022x035		
							55	BR00/10x022x055		
						27	25	BR00/10x027x025		
							35	BR00/10x027x035		
							55	BR00/10x027x055		
							75	BR00/10x027x075		
						36	25	BR00/10x036x025		
							35	BR00/10x036x035		
							55	BR00/10x036x055		
75	BR00/10x036x075									
46	35	BR00/10x046x035								
	55	BR00/10x046x055								
	75	BR00/10x046x075								
56	35	BR00/10x056x035								
	55	BR00/10x056x055								
	75	BR00/10x056x075								
6	7	9	25	20	14	17	35	BR00/14x017x035	15	BR00/15x017x035
							55	BR00/14x017x055		BR00/15x017x055

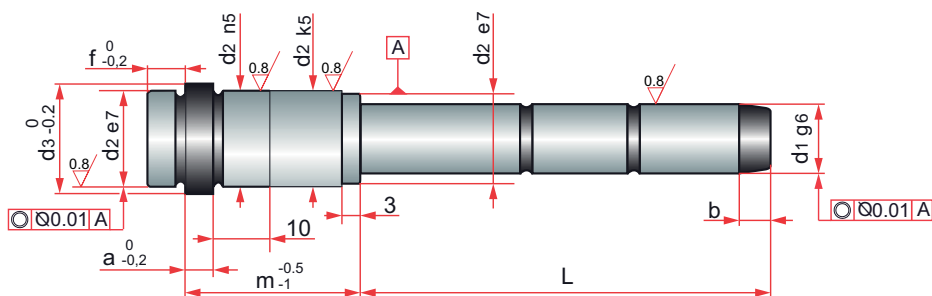

a	b	f	d3	d2	d1	m	L	REF.	d1	REF.			
6	7	9	25	20	14	56	75	BR00/14x056x075	15	BR00/15x056x075			
							95	BR00/14x056x095		BR00/15x056x095			
							135	BR00/14x056x135		BR00/15x056x135			
						66	55	BR00/14x066x055		BR00/15x066x055			
							65	BR00/14x066x065		BR00/15x066x065			
							95	BR00/14x066x095		BR00/15x066x095			
						76	55	BR00/14x076x055		BR00/15x076x055			
							95	BR00/14x076x095		BR00/15x076x095			
							105	BR00/14x076x105		BR00/15x076x105			
						86	55	BR00/14x086x055		BR00/15x086x055			
							75	BR00/14x086x075		BR00/15x086x075			
							95	BR00/14x086x095		BR00/15x086x095			
			115	BR00/14x086x115	BR00/15x086x115								
			96	55	BR00/14x096x055	BR00/15x096x055							
				95	BR00/14x096x095	BR00/15x096x095							
			116	75	BR00/14x116x075	BR00/15x116x075							
			31	26	18	22	20	18	22	35	BR00/18x022x035	20	BR00/20x022x035
										45	BR00/18x022x045		BR00/20x022x045
										65	BR00/18x022x065		BR00/20x022x065
										85	BR00/18x022x085		BR00/20x022x085
										115	BR00/18x022x115		BR00/20x022x115
									27	35	BR00/18x027x035		BR00/20x027x035
										45	BR00/18x027x045		BR00/20x027x045
										65	BR00/18x027x065		BR00/20x027x065
85	BR00/18x027x085	BR00/20x027x085											
36	105	BR00/18x027x105				BR00/20x027x105							
	125	BR00/18x027x125				BR00/20x027x125							
	35	BR00/18x036x035				BR00/20x036x035							
	55	BR00/18x036x055				BR00/20x036x055							
	75	BR00/18x036x075				BR00/20x036x075							
95	BR00/18x036x095	BR00/20x036x095											

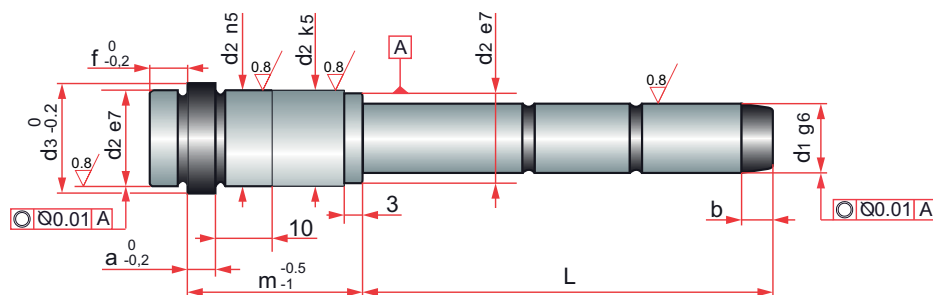

a	b	f	d3	d2	d1	m	L	REF.	d1	REF.	
6	7	9	31	26	18	36	115	BR00/18x036x115	20	BR00/20x036x115	
							135	BR00/18x036x135		BR00/20x036x135	
							46	35		BR00/18x046x035	BR00/20x046x035
								45		BR00/18x046x045	BR00/20x046x045
								65		BR00/18x046x065	BR00/20x046x065
								85		BR00/18x046x085	BR00/20x046x085
								105		BR00/18x046x105	BR00/20x046x105
						135		BR00/18x046x135		BR00/20x046x135	
						56	35	BR00/18x056x035		BR00/20x056x035	
							55	BR00/18x056x055		BR00/20x056x055	
							75	BR00/18x056x075		BR00/20x056x075	
							85	BR00/18x056x085		BR00/20x056x085	
							95	BR00/18x056x095		BR00/20x056x095	
							155	BR00/18x056x155		BR00/20x056x155	
						66	35	BR00/18x066x035		BR00/20x066x035	
							55	BR00/18x066x055		BR00/20x066x055	
							75	BR00/18x066x075		BR00/20x066x075	
							95	BR00/18x066x095		BR00/20x066x095	
							145	BR00/18x066x145		BR00/20x066x145	
						76	55	BR00/18x076x055		BR00/20x076x055	
							75	BR00/18x076x075		BR00/20x076x075	
							95	BR00/18x076x095		BR00/20x076x095	
							135	BR00/18x076x135		BR00/20x076x135	
						86	55	BR00/18x086x055		BR00/20x086x055	
							75	BR00/18x086x075		BR00/20x086x075	
							95	BR00/18x086x095		BR00/20x086x095	
							115	BR00/18x086x115		BR00/20x086x115	
							155	BR00/18x086x155		BR00/20x086x155	
96	55	BR00/18x096x055	BR00/20x096x055								
	95	BR00/18x096x095	BR00/20x096x095								
116	75	BR00/18x116x075	BR00/20x116x075								
	115	BR00/18x116x115	BR00/20x116x115								

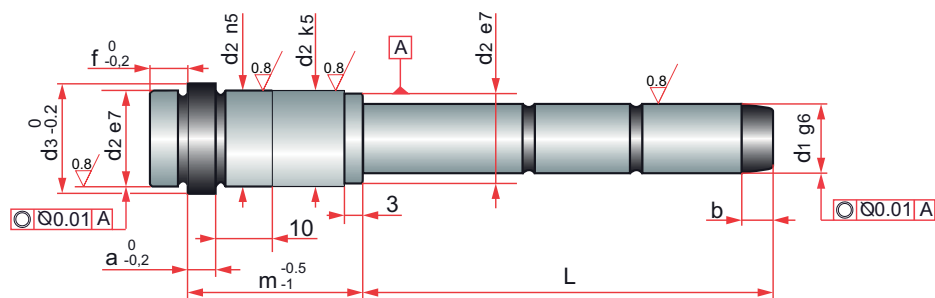

a	b	f	d3	d2	d1	m	L	REF.	d1	REF.
6	7	9	35	30	22	22	35	BR00/22x022x035	24	BR00/24x022x035
							55	BR00/22x022x055		BR00/24x022x055
							75	BR00/22x022x075		BR00/24x022x075
							105	BR00/22x022x105		BR00/24x022x105
							130	BR00/22x022x130		BR00/24x022x130
						27	35	BR00/22x027x035	BR00/24x027x035	
							45	BR00/22x027x045	BR00/24x027x045	
							65	BR00/22x027x065	BR00/24x027x065	
							85	BR00/22x027x085	BR00/24x027x085	
							105	BR00/22x027x105	BR00/24x027x105	
							125	BR00/22x027x125	BR00/24x027x125	
							165	BR00/22x027x165	BR00/24x027x165	
							36	35	BR00/22x036x035	BR00/24x036x035
						55		BR00/22x036x055	BR00/24x036x055	
						75		BR00/22x036x075	BR00/24x036x075	
						95		BR00/22x036x095	BR00/24x036x095	
						115		BR00/22x036x115	BR00/24x036x115	
						135		BR00/22x036x135	BR00/24x036x135	
						165		BR00/22x036x165	BR00/24x036x165	
						205		BR00/22x036x205	BR00/24x036x205	
						46	35	BR00/22x046x035	BR00/24x046x035	
							45	BR00/22x046x045	BR00/24x046x045	
							65	BR00/22x046x065	BR00/24x046x065	
							85	BR00/22x046x085	BR00/24x046x085	
							105	BR00/22x046x105	BR00/24x046x105	
							125	BR00/22x046x125	BR00/24x046x125	
							165	BR00/22x046x165	BR00/24x046x165	
							205	BR00/22x046x205	BR00/24x046x205	
						56	35	BR00/22x056x035	BR00/24x056x035	
							55	BR00/22x056x055	BR00/24x056x055	
							75	BR00/22x056x075	BR00/24x056x075	
							95	BR00/22x056x095	BR00/24x056x095	

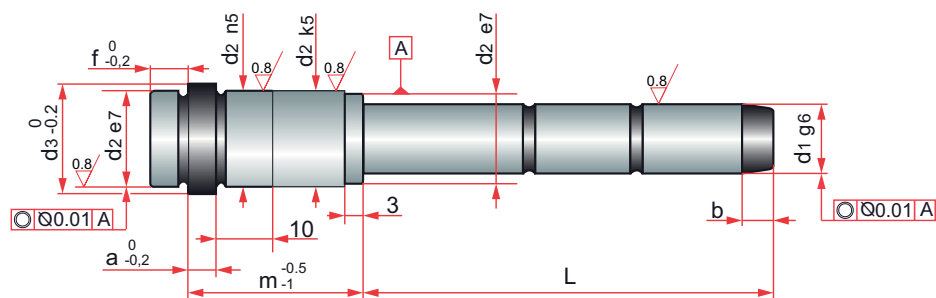

a	b	f	d3	d2	d1	m	L	REF.	d1	REF.	
6	7	9	35	30	22	56	115	BR00/22x056x115	24	BR00/24x056x115	
							165	BR00/22x056x165		BR00/24x056x165	
							205	BR00/22x056x205		BR00/24x056x205	
							66	35		BR00/22x066x035	BR00/24x066x035
								55		BR00/22x066x055	BR00/24x066x055
								75		BR00/22x066x075	BR00/24x066x075
								95		BR00/22x066x095	BR00/24x066x095
								155		BR00/22x066x155	BR00/24x066x155
								205		BR00/22x066x205	BR00/24x066x205
							76	55		BR00/22x076x055	BR00/24x076x055
								75		BR00/22x076x075	BR00/24x076x075
								95		BR00/22x076x095	BR00/24x076x095
						115		BR00/22x076x115	BR00/24x076x115		
						145		BR00/22x076x145	BR00/24x076x145		
						165		BR00/22x076x165	BR00/24x076x165		
						205		BR00/22x076x205	BR00/24x076x205		
						86		55	BR00/22x086x055	BR00/24x086x055	
							75	BR00/22x086x075	BR00/24x086x075		
							95	BR00/22x086x095	BR00/24x086x095		
							115	BR00/22x086x115	BR00/24x086x115		
							155	BR00/22x086x155	BR00/24x086x155		
							205	BR00/22x086x205	BR00/24x086x205		
						96	55	BR00/22x096x055	BR00/24x096x055		
							75	BR00/22x096x075	BR00/24x096x075		
							95	BR00/22x096x095	BR00/24x096x095		
							125	BR00/22x096x125	BR00/24x096x125		
							155	BR00/22x096x155	BR00/24x096x155		
							205	BR00/22x096x205	BR00/24x096x205		
						116	75	BR00/22x116x075	BR00/24x116x075		
							115	BR00/22x116x115	BR00/24x116x115		
							155	BR00/22x116x155	BR00/24x116x155		
							205	BR00/22x116x205	BR00/24x116x205		

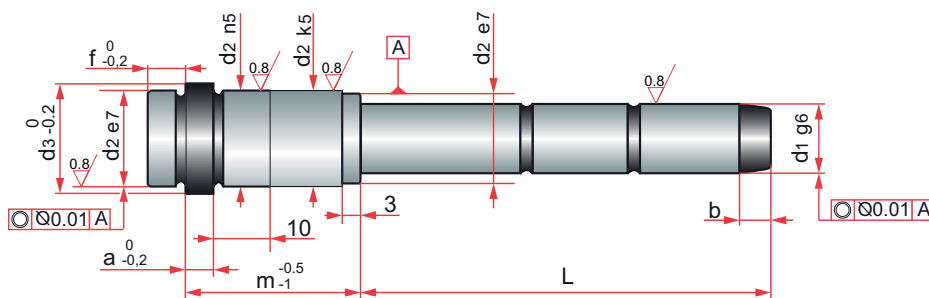

a	b	f	d3	d2	d1	m	L	REF.	d1	REF.				
6	7	9	35	30	22	136	95	BR00/22x136x095	24	BR00/24x136x095				
							135	BR00/22x136x135		BR00/24x136x135				
							155	BR00/22x136x155		BR00/24x136x155				
							205	BR00/22x136x205		BR00/24x136x205				
						47	42	30		27	45	BR00/30x027x045	32	BR00/32x027x045
											65	BR00/30x027x065		BR00/32x027x065
											105	BR00/30x027x105		BR00/32x027x105
										36	55	BR00/30x036x055		BR00/32x036x055
			75	BR00/30x036x075	BR00/32x036x075									
			95	BR00/30x036x095	BR00/32x036x095									
			115	BR00/30x036x115	BR00/32x036x115									
			46	45	BR00/30x046x045				BR00/32x046x045					
				65	BR00/30x046x065				BR00/32x046x065					
				85	BR00/30x046x085				BR00/32x046x085					
				105	BR00/30x046x105				BR00/32x046x105					
			56	55	BR00/30x056x055				BR00/32x056x055					
				75	BR00/30x056x075	BR00/32x056x075								
				95	BR00/30x056x095	BR00/32x056x095								
				115	BR00/30x056x115	BR00/32x056x115								
				135	BR00/30x056x135	BR00/32x056x135								
			66	205	BR00/30x056x205	BR00/32x056x205								
				55	BR00/30x066x055	BR00/32x066x055								
				75	BR00/30x066x075	BR00/32x066x075								
				95	BR00/30x066x095	BR00/32x066x095								
				115	BR00/30x066x115	BR00/32x066x115								
			76	135	BR00/30x066x135	BR00/32x066x135								
				205	BR00/30x066x205	BR00/32x066x205								
				55	BR00/30x076x055	BR00/32x076x055								
				75	BR00/30x076x075	BR00/32x076x075								
			47							95	BR00/30x076x095	BR00/32x076x095		
										115	BR00/30x076x115	BR00/32x076x115		
										155	BR00/30x076x155	BR00/32x076x155		

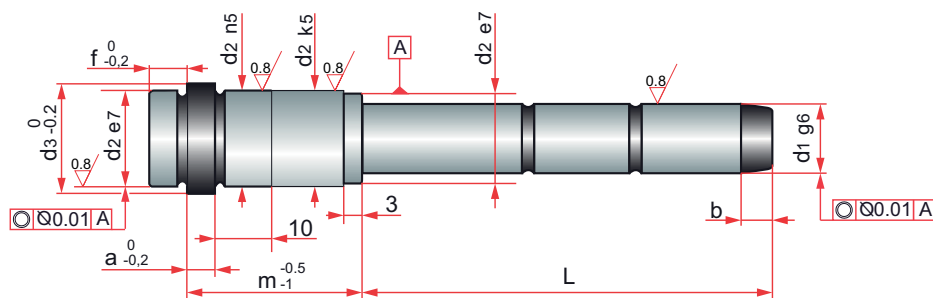

a	b	f	d3	d2	d1	m	L	REF.	d1	REF.							
6	7	9	47	42	30	76	205	BR00/30x076x205	32	BR00/32x076x205							
							86	55		BR00/30x086x055	BR00/32x086x055						
								75		BR00/30x086x075	BR00/32x086x075						
								95		BR00/30x086x095	BR00/32x086x095						
								115		BR00/30x086x115	BR00/32x086x115						
								135		BR00/30x086x135	BR00/32x086x135						
								155		BR00/30x086x155	BR00/32x086x155						
								205		BR00/30x086x205	BR00/32x086x205						
						96	55	BR00/30x096x055		BR00/32x096x055							
							75	BR00/30x096x075		BR00/32x096x075							
							95	BR00/30x096x095		BR00/32x096x095							
							115	BR00/30x096x115		BR00/32x096x115							
							135	BR00/30x096x135		BR00/32x096x135							
							155	BR00/30x096x155		BR00/32x096x155							
							205	BR00/30x096x205		BR00/32x096x205							
							116	75		BR00/30x116x075	BR00/32x116x075						
						115		BR00/30x116x115		BR00/32x116x115							
						155		BR00/30x116x155		BR00/32x116x155							
						205		BR00/30x116x205		BR00/32x116x205							
						136	95	BR00/30x136x095		BR00/32x136x095							
							115	BR00/30x136x115		BR00/32x136x115							
							155	BR00/30x136x155		BR00/32x136x155							
							205	BR00/30x136x205		BR00/32x136x205							
						156	115	BR00/30x156x115		BR00/32x156x115							
							155	BR00/30x156x155		BR00/32x156x155							
							205	BR00/30x156x205		BR00/32x156x205							
						10	10	12		59	54	40	36	75	BR00/40x036x075	42	BR00/42x036x075
														95	BR00/40x036x095		BR00/42x036x095
115	BR00/40x036x115	BR00/42x036x115															
155	BR00/40x036x155	BR00/42x036x155															
46	75	BR00/40x046x075	BR00/42x046x075														
	95	BR00/40x046x095	BR00/42x046x095														

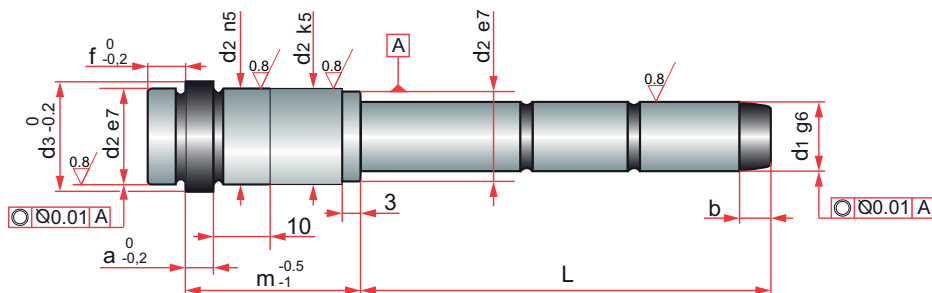

a	b	f	d3	d2	d1	m	L	REF.	d1	REF.	
10	10	12	59	54	40	46	115	BR00/40x046x115	42	BR00/42x046x115	
							155	BR00/40x046x155		BR00/42x046x155	
							56	75		BR00/40x056x075	BR00/42x056x075
								95		BR00/40x056x095	BR00/42x056x095
								115		BR00/40x056x115	BR00/42x056x115
								155		BR00/40x056x155	BR00/42x056x155
						66	75	BR00/40x066x075		BR00/42x066x075	
							95	BR00/40x066x095		BR00/42x066x095	
							115	BR00/40x066x115		BR00/42x066x115	
							155	BR00/40x066x155		BR00/42x066x155	
						76	75	BR00/40x076x075		BR00/42x076x075	
							95	BR00/40x076x095		BR00/42x076x095	
							115	BR00/40x076x115		BR00/42x076x115	
							155	BR00/40x076x155		BR00/42x076x155	
						86	75	BR00/40x086x075		BR00/42x086x075	
							95	BR00/40x086x095		BR00/42x086x095	
							115	BR00/40x086x115		BR00/42x086x115	
							155	BR00/40x086x155		BR00/42x086x155	
						96	75	BR00/40x096x075		BR00/42x096x075	
							95	BR00/40x096x095		BR00/42x096x095	
							115	BR00/40x096x115		BR00/42x096x115	
							155	BR00/40x096x155		BR00/42x096x155	
							195	BR00/40x096x195		BR00/42x096x195	
						116	75	BR00/40x116x075		BR00/42x116x075	
							95	BR00/40x116x095		BR00/42x116x095	
							115	BR00/40x116x115		BR00/42x116x115	
							155	BR00/40x116x155		BR00/42x116x155	
							195	BR00/40x116x195		BR00/42x116x195	
						136	95	BR00/40x136x095		BR00/42x136x095	
							115	BR00/40x136x115		BR00/42x136x115	
							135	BR00/40x136x135		BR00/42x136x135	

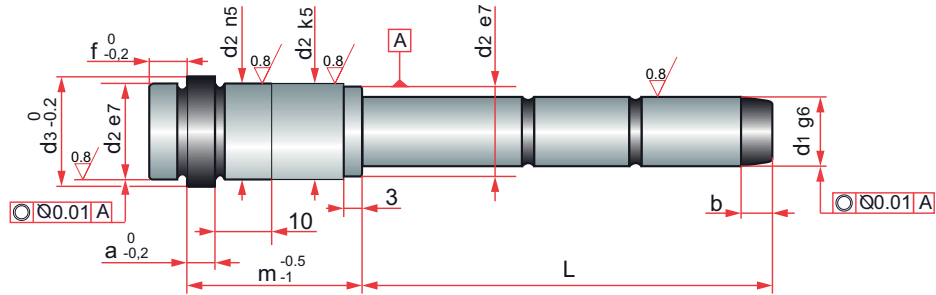

a	b	f	d3	d2	d1	m	L	REF.	d1	REF.
10	10	12	59	54	40	136	155	BR00/40x136x155	42	BR00/42x136x155
							195	BR00/40x136x195		BR00/42x136x195
						156	115	BR00/40x156x115		BR00/42x156x115
							135	BR00/40x156x135		BR00/42x156x135
							155	BR00/40x156x155		BR00/42x156x155
						176	195	BR00/40x156x195		BR00/42x156x195
							115	BR00/40x176x115		BR00/42x176x115
							155	BR00/40x176x155		BR00/42x176x155
							195	BR00/40x176x195		BR00/42x176x195
						196	235	BR00/40x176x235		BR00/42x176x235
							115	BR00/40x196x115		BR00/42x196x115
							155	BR00/40x196x155		BR00/42x196x155
							195	BR00/40x196x195		BR00/42x196x195
						216	235	BR00/40x196x235		BR00/42x196x235
							195	BR00/40x216x195		BR00/42x216x195
						236	215	BR00/40x216x215		BR00/42x216x215
							205	BR00/40x236x205		BR00/42x236x205
						246	235	BR00/40x236x235		BR00/42x236x235
							215	BR00/40x246x215		BR00/42x246x215
						256	245	BR00/40x246x245		BR00/42x246x245
							215	BR00/40x256x215		BR00/42x256x215
							255	BR00/40x256x255		BR00/42x256x255