

# 346.346

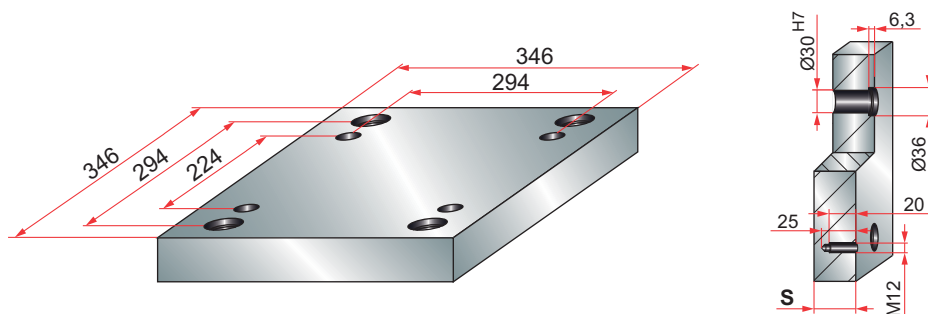

## PBA

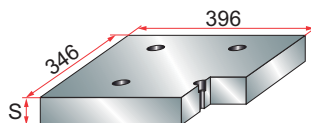

PBA	
S	27
	36

mat.: 1.1730

## PBA-EU

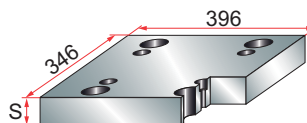

PBA-EU	
S	27
	36

mat.: 1.1730

## PBAV

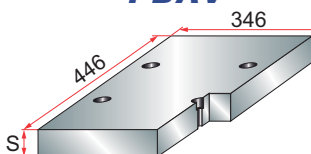

PBAV	
S	27
	36

mat.: 1.1730

## PBAV-EU

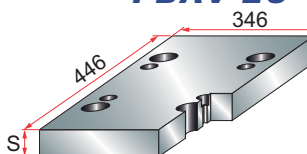

PBAV-EU	
S	27
	36

mat.: 1.1730

## PBAS

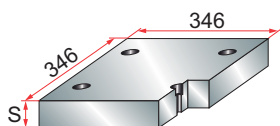

PBAS	
S	27
	36
	46

mat.: 1.1730

## PBAS-EU

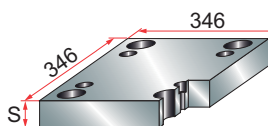

PBAS-EU	
S	27
	36
	46

mat.: 1.1730

## PC

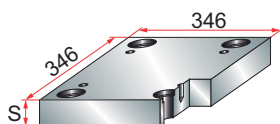

		Material			
		1.1730	1.2311	1.2312	1.2085
S	27	*	*	*	o
	36	*	*	*	o
	46	*	*	*	o
	56	*	*	*	o
	66	*	*	*	o
	76	*	*	*	o
	86	*	*	*	o
	96	*	*	*	o
	116	*	*	*	o
	136	*	*	*	o
	156	*	*	*	o

° Entrega 3/4 dias - Delivery 3/4 days

## PCX

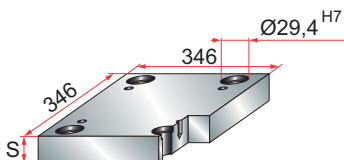

		Material		
		1.2311	1.2312	1.2085
S	27	*	*	o
	36	*	*	o
	46	*	*	o
	56	*	*	o
	66	*	*	o
	76	*	*	o
	86	*	*	o
	96	*	*	o
	116	*	*	o
	136	*	*	o
	156	*	*	o

° Entrega 3/4 dias - Delivery 3/4 days

# 346.346

## PS

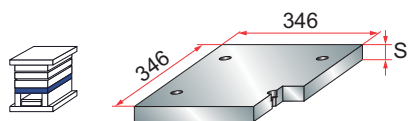

PS	
S	27
	36
	46

mat.: 1.1730

## PS-EU

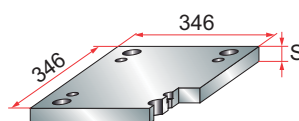

PS-EU	
S	27
	36
	46

mat.: 1.1730

## ESP

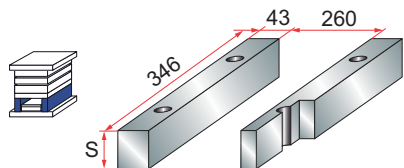

ESP	
S	56
	66
	76
	86
	96

mat.: 1.1730

## ESP-EU

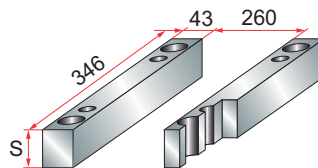

ESP-EU	
S	56
	66
	76
	86
	96
	116

mat.: 1.1730

## CPE

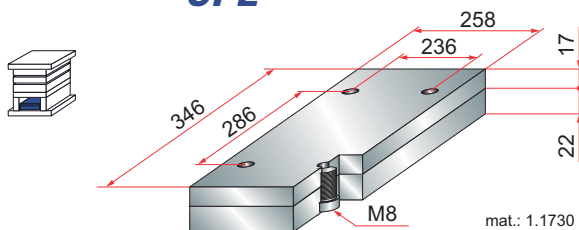

mat.: 1.1730  
mat.: 1.2311

## P PLATES

### PBA-P

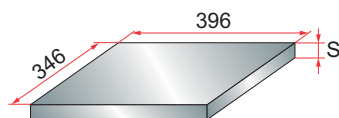

PBA-P	
S	27
	36

mat.: 1.1730

### PBAV-P

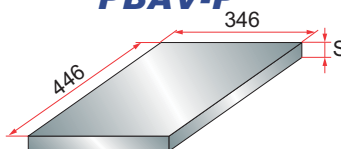

PBAV-P	
S	27
	36

mat.: 1.1730

### PC-P

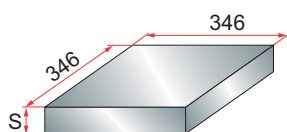

S	Material			
	1.1730	1.2311	1.2312	1.2085
27	*	*	*	o
36	*	*	*	o
46	*	*	*	o
56	*	*	*	o
66	*	*	*	o
76	*	*	*	o
86	*	*	*	o
96	*	*	*	o
116	*	*	*	o
136	*	*	*	o
156	*	*	*	o

° Entrega 3/4 dias - Delivery 3/4 days

### ESP-P

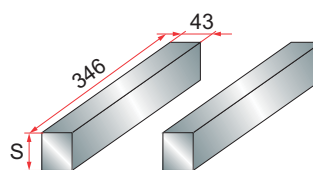

ESP-P	
S	56
	66
	76
	86
	96
	116

mat.: 1.1730

### PS-P

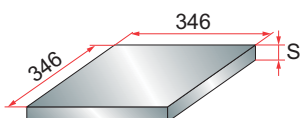

PS-P	
S	27
	36
	46

mat.: 1.1730

### CPE-P

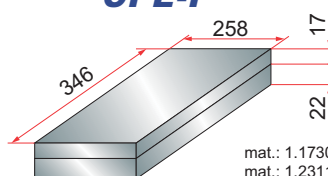

mat.: 1.1730  
mat.: 1.2311